

Dry Pipe Valve

Flange x Flange - AF

Manufactured by: Central Sprinkler Company
451 North Cannon Avenue, Lansdale, Pennsylvania 19446



Product Description

The Central Dry Pipe Valve is a dry pipe sprinkler system water-supply control valve that makes possible the installation of sprinkler systems in buildings subject to freezing temperatures. It is designed so that air pressure in the piping system will hold back water pressure at the valve until such time as a sprinkler is activated. Upon such activation the air pressure in the system will be decreased sufficiently to cause automatic operation of the valve and admission of water into the system.

It is a 5:1 differential type valve having a clapper air seat of large diameter relative to the water seat. The two concentric seats are separated by an intermediate chamber normally maintained at atmospheric pressure.

The Dry Pipe Valve Trim package includes the necessary valves, gauges, fittings and nipples to provide an air supply connection, priming water connection, drain connections, alarm connection, and alarm test bypass. The Dry Pipe Valves are Listed/Approved with Central's Trim. Any substitutions or omissions may void such Listings and Approvals, without prior approval from Central Sprinkler.

Central's Air Maintenance Device for owner's air supply or automatic air compressor supply may be easily connected to the Dry Pipe Valve Trim.

The Dry Pipe Valve is available in the flange-by-flange style.

The Valves are Listed by Underwriter's Laboratories, and Approved by Factory Mutual for use in fire sprinkler systems with a maximum working pressure of 175 psi.

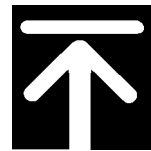

Technical Data

Model: AF
Style: Flange-x-Flange
Size: 2" & 2 1/2"
Approvals: U.L., F.M., U.L.C.
Maximum Working Pressure: 175 psi
Factory Hydro Test: 100% at 350 psi
(with clapper open)

Standard Finish: Blue enamel
Flange Specifications:
AF Inlet - Class 125 ANSI B16.1
AF Outlet - Class 125 ANSI B16.1
Piping Take-Out: 12"
Required Accessories:
Standard Trim (as shown)

Optional Accessories:
Air Maintenance Device
Air Compressor
Pressure Alarm Switch
Water Motor Alarm
Low Air Pressure Switch

Mfgr. Source: U.S.

Weight:
Valve - 70 lbs.
Trim - 38 lbs.

2" & 2 1/2" Dry Pipe Valve & Trim

Figure 1
Dry Pipe Valve Section

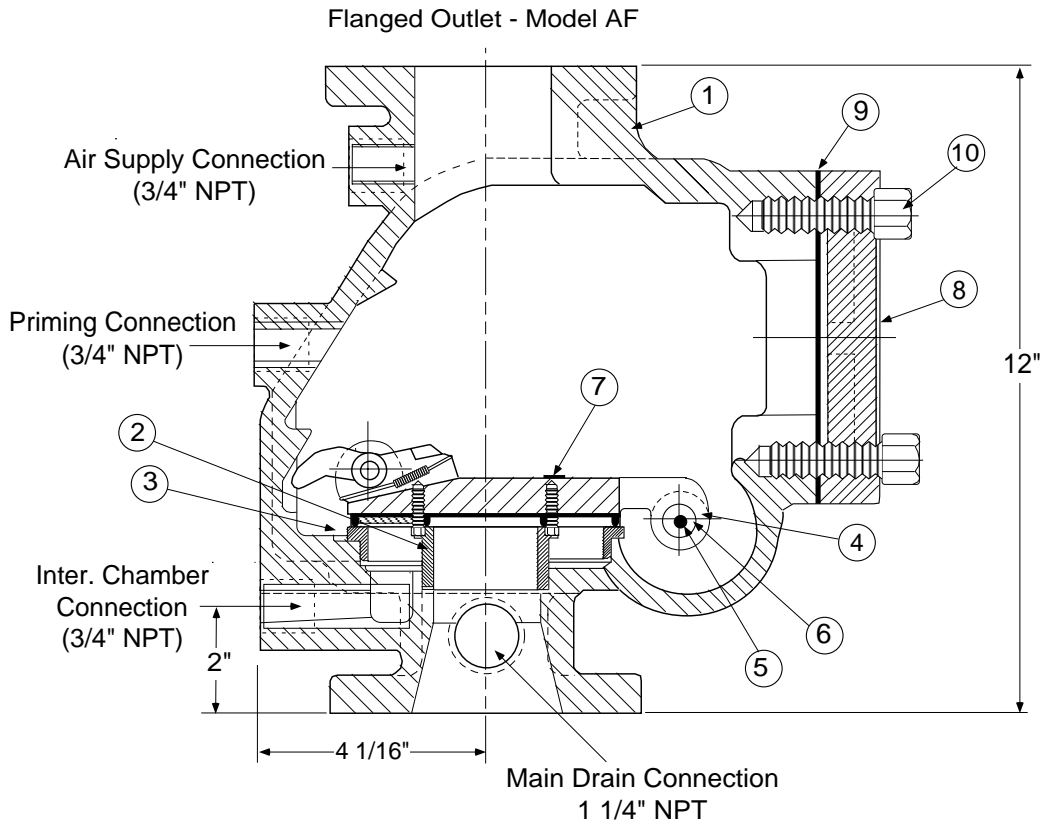

Note: The Clapper Assembly may be removed from the body of the Dry Pipe Valve by removing the two 3/8\"

Parts List - Dry Pipe Valve

Model AF (2\"

Identification Number	Number Required	Description	Part Number (2\"
1	1	Body (2\"	200-188-00
1	1	Body (2 1/2\"	200-188-04
2	1	Water Seat Ring*	200-183-00
3	1	Air Seat Ring*	200-184-00
4	2	Body Bushing	300-187-00
5	1	Hinge Pin	818-10-100
6	2	Pipe Plug, 3/8\"-18 NPT	818-12-000
7	1	Clapper Assembly	200-186-00
8	1	Cover	250-02-000
9	1	Cover Gasket	250-04-000
10	4	Cover Bolt 3/4\"-10 x 2\" Long	600-03-000

*Not field replaceable.

Figure 2
Dry Pipe Valve Clapper Assembly

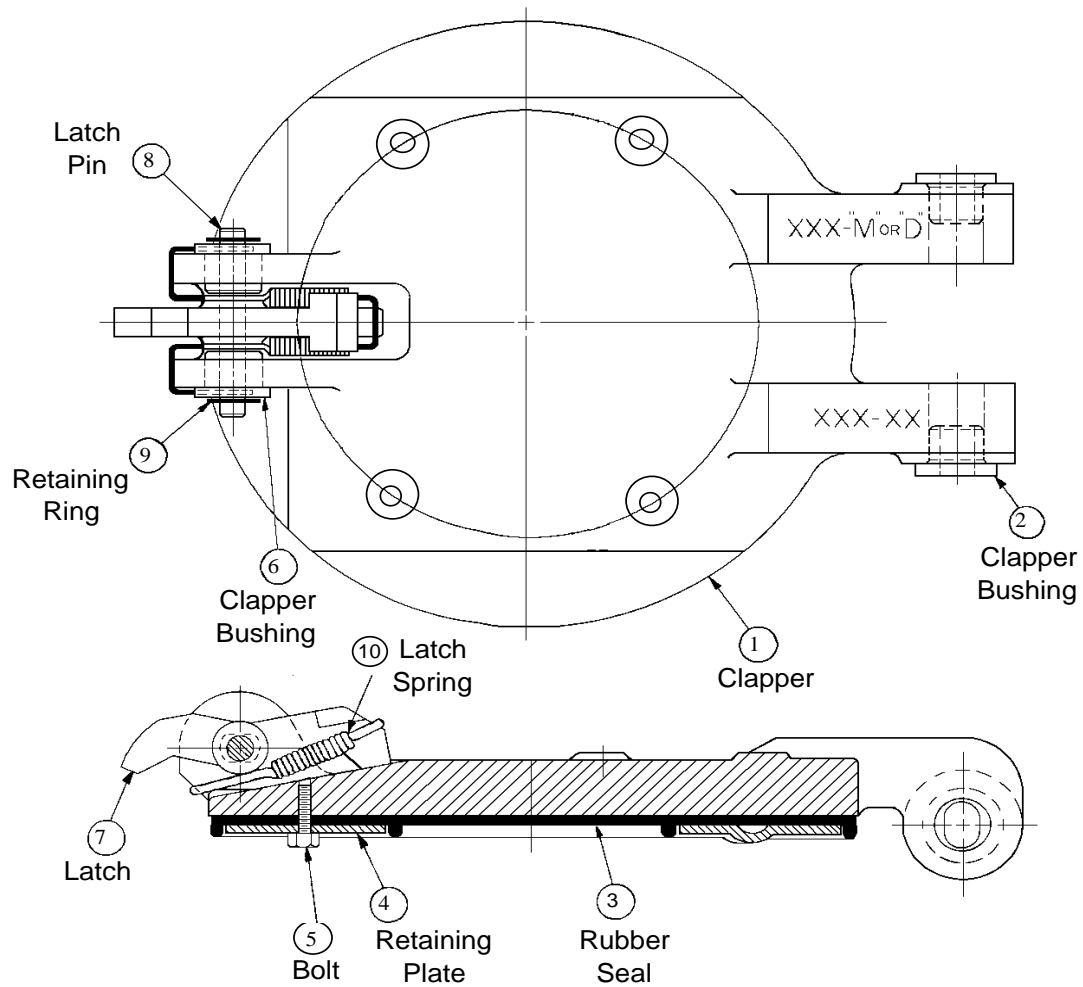

Parts List - Clapper Assembly
Model AF (2" & 2 1/2" Assembly No. 200-186-000)

Identification Number	Number Required	Description	Part Number (2" & 2 1/2" Size)
1	1	Clapper	200-182-00
2	2	Clapper Bushing (thru body)	818-08-000
3	1	Rubber Seal	200-180-00
4	1	Retaining Plate	200-181-00
5	4	1/4"-20 x 5/8" Hex Head Bolts	300-16-000
6	2	Clapper Bushing (thru latch)	818-08-000
7	1	Latch	300-10-000
8	1	Latch Pin	300-23-000
9	2	Retaining Ring	300-22-000
10	1	Latch Spring	300-21-000



Operation

When the Dry Pipe Valve is in the set position, the rubber-faced clapper is tightly closed on two concentric seat rings. The inner ring is the water ring and the outer ring is the air ring. The annular space between the two seat rings (intermediate chamber) is open to the atmosphere via the alarm connection trim piping to the normally open automatic ball drip valve.

Priming water is provided above the clapper up to the level of the priming connection. Above the priming water, compressed air (or nitrogen) is maintained at a pressure sufficient to hold the clapper closed. The Dry Pipe Valve has a differential trip ratio of approximately 5 to 1. Thus the valve will open (trip) when the air pressure in the system piping is reduced to approximately one-fifth of the water supply pressure.

The purpose of the priming water is to assist in providing a positive seal at the air seat ring to prevent air from escaping into the intermediate chamber and on to the atmosphere. The clapper will remain in the closed position as long as the air pressure in the piping system is maintained at the proper level.

When a sprinkler operates, the air pressure in the piping system decays due to the air escaping from the opened sprinkler. When the air pressure has decayed to the point that it is no longer adequate to hold the clapper shut, the water supply pressure lifts the clapper which automatically latches in the open position. Water flows into the system piping to the open sprinkler(s). At the same time, water flows via the intermediate chamber into the alarm connection trim piping (closing the automatic ball drip valve) and continues on through the alarm line to operate the pressure actuated alarm switch and/or the water motor alarm.

When a sprinkler opens, the resulting air pressure decay is inversely proportional to the volume of air in the sprinkler piping.

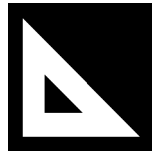

Design Data

DESIGN CONSIDERATIONS

General

The Central Model AF Dry Pipe Valves must be installed in the vertical position. They should be located in a sprinklered area not subject to freezing conditions, such as a well-lighted and heated valve house or similar enclosure having sufficient room to enable ease of installation, care and maintenance.

When properly installed, the Trim on the Dry Pipe Valve protrudes the following horizontal distances from the center line (C.L.) of the riser:

Trim Protrusion*	2" & 2 1/2" Valve
C.L. to left	11 1/2"
C.L. to right	15"
C.L. to rear	11 1/2"

* When the observer is facing the valve body cover plate.

Drawings

The dry pipe system working drawings must show:

1. The manufacturer, style, model number, and size of the Dry Pipe Valve.
2. The total number of sprinklers on each dry pipe system, and,
3. The capacity (gallons) of each dry pipe system.

Pendent sprinklers in dry pipe systems must be of the dry pendent type in areas that are subject to freezing.

Dry pipe systems that supply freezer areas must be equipped with a local, Low Air Pressure Alarm which may be connected to the system riser just above the Dry Pipe Valve. For "freezer area" systems, a desiccant air dryer should be provided in the air supply line to remove moisture from the compressed air.

Dry System Capacity

The capacity (gallons) of the piping system may be calculated using the following table:

Diameter (in.)	Capacity (gal./ft.)	
	Sch. 40	Sch. 10
3/4	.028	—
1	.045	.049
1 1/4	.078	.085
1 1/2	.106	.115
2	.174	.190
2 1/2	.248	.283
3	.383	.433
4	.660	.740
6	1.50 ¹	1.649 ¹
8	2.66 ³	2.776 ²

¹ 0.134" wall pipe

² 0.188" wall pipe

³ Schedule 30 pipe

In accordance with current NFPA 13, the maximum allowable capacity of a single dry pipe system is normally 750 gallons. The capacity may exceed 750 gallons only if water can be delivered to the inspector's test connection in 60 seconds or less.

Air Compressor

The compressed air supply for the dry pipe system is usually provided by a continuously available, electrically driven, air compressor which is automatically controlled to turn on and off at the designed minimum and maximum pressures, respectively. After initial pressurization of the system, the air supply is maintained through an in-line, 1/8" orifice in the piping of the Air Maintenance Device. The orifice is small enough that when a sprinkler opens, the air supply will not interfere with the operation of the Dry Pipe Valve by rapidly supplying additional air pressure to the upper chamber of the Dry Pipe Valve.

The air compressor must be adequately sized to be able to bring the system air pressure up to the design level in 30 minutes or less. The required size of the air compressor in C.F.M., may be determined from the following equation:

C.F.M. = 0.012 X System Capacity (gallons), where C.F.M. is the free air delivery in cubic feet per minute based on standard air at sea level.

Friction Loss

For use in hydraulic calculations, the pressure loss through the Dry Pipe Valve may be expressed as equivalent length of schedule 40, C=120 pipe as follows:

2" & 2 1/2" Valve = 23 feet

Drainage (per NFPA 13)

The dry pipe system must be designed so that all portions of the piping system may be drained. In order to assure proper drainage:

1. Branch lines, cross and feed mains shall be pitched in accordance with NFPA 13, Sec. 3-6.1.3.
2. Trapped sections of piping must be equipped with auxiliary drains as follows:
 - a. If the trapped section is less than 5 gallons capacity, provide a 3/4" valve with plug or with nipple and cap.
 - b. If the trapped section is greater than 5 gallons capacity, provide a drum drip (2" x 12" pipe nipple with a 1" valve on each end) with the outlet valve equipped with a plug or nipple and cap.

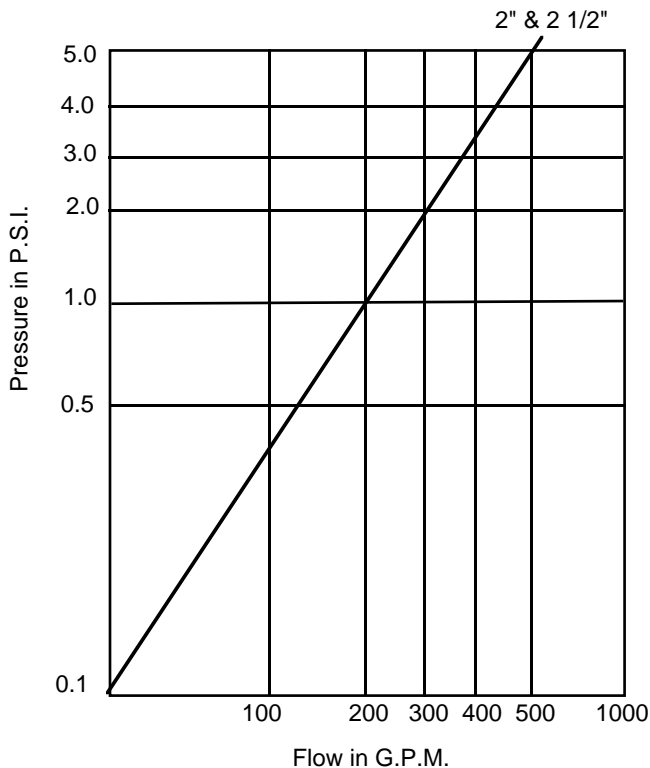

Installation

General

Dry Pipe Valves must be installed in a sprinklered area not subject to freezing conditions, such as a well-lighted and heated valve house or similar enclosure having sufficient room to enable ease of installation, care and maintenance.

Prior to installing the Dry Pipe Valve in the piping system, the water supply line must be thoroughly flushed to assure that no foreign matter is present.

The valve must be installed in the vertical position in the system piping. Trim according to the Trim Assembly Diagram on page 7.

Remove the hand hole cover and gasket and check the valve clapper for freedom of movement.

In order to place the Dry Pipe Valve into operation, the valve must be "set" (see Setting Procedure). The system side of the valve clapper assembly must be primed with water to the level of the priming connection.

**Note: Priming water is as follows:
2" & 2 1/2" = 3/4 Gallon**

The system piping must be subsequently pressurized with air (or nitrogen) via the air connection. After priming and pressurization of the Dry Pipe Valve, the main system water control valve must be opened fully. After initial installation, the alarm test, main drain test and trip test(s) must be performed and the system reset and placed in service.

It is recommended that Central's Automatic Air Maintenance Device be permanently connected to the system to avoid the possibility of false valve trips which may result from small piping leaks gradually lowering system air pressure.

If difficulty in performance is experienced, Central Sprinkler Company should be contacted if any field adjustment is to be made.

Setting Procedure

Step 1. Close the main water supply control valve to the sprinkler system (OS&Y, PIV or other).

Step 2. Close all valves in the Dry Pipe Valve Trim, except the 1/4" three-way valves (Fig. 5, #8) at the Air Pressure Gauge and Water Pressure Gauge.

Step 3. Open the system main drain valve, the system inspector's test valve, and all system auxiliary drain valves connected to the piping. Replace any sprinklers which may have activated.

By keeping the inspector's test connection open, the system piping will be maintained at atmospheric pressure and the test connection will serve as a vent during system drainage and during priming of the Dry Pipe Valve.

Step 4. After all drainage has stopped, tightly close all auxiliary drain valves. Leave the inspector's test valve and system main drain valve open.

Figure 3 - Set Position

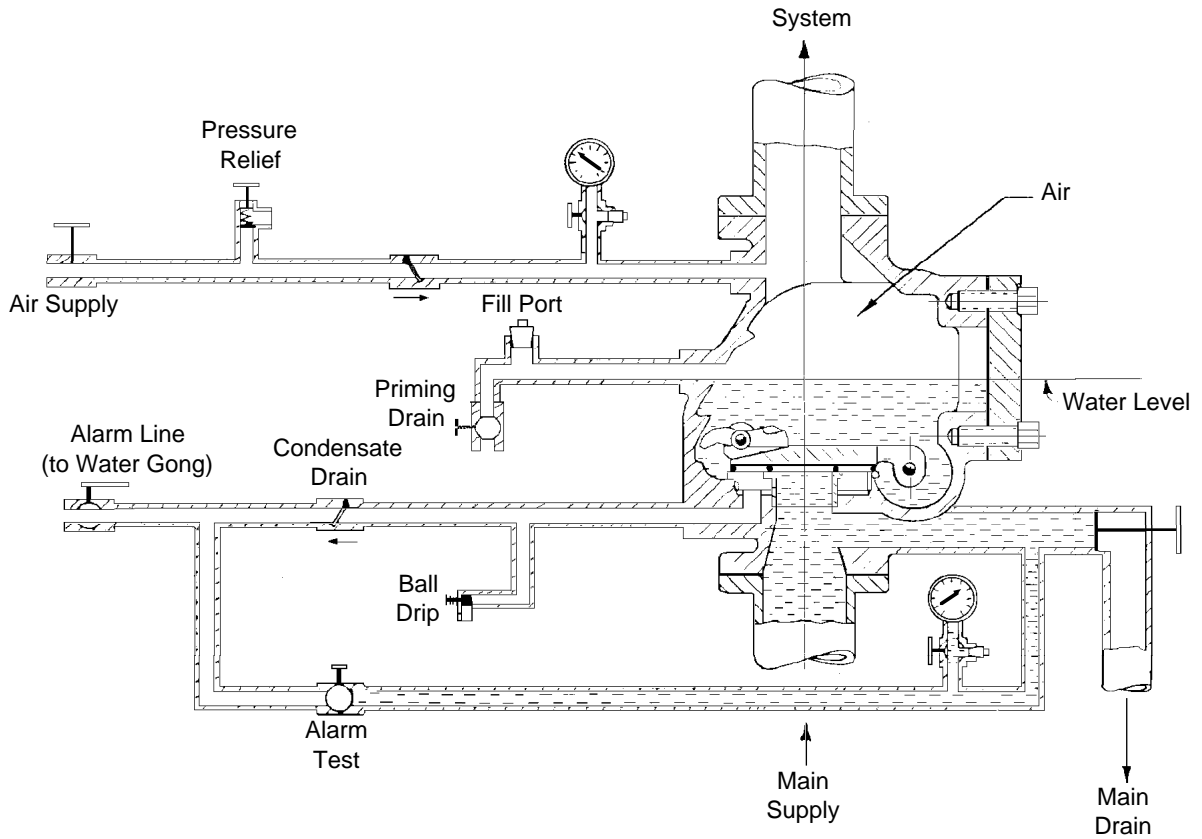

Figure 4 - Activated Position

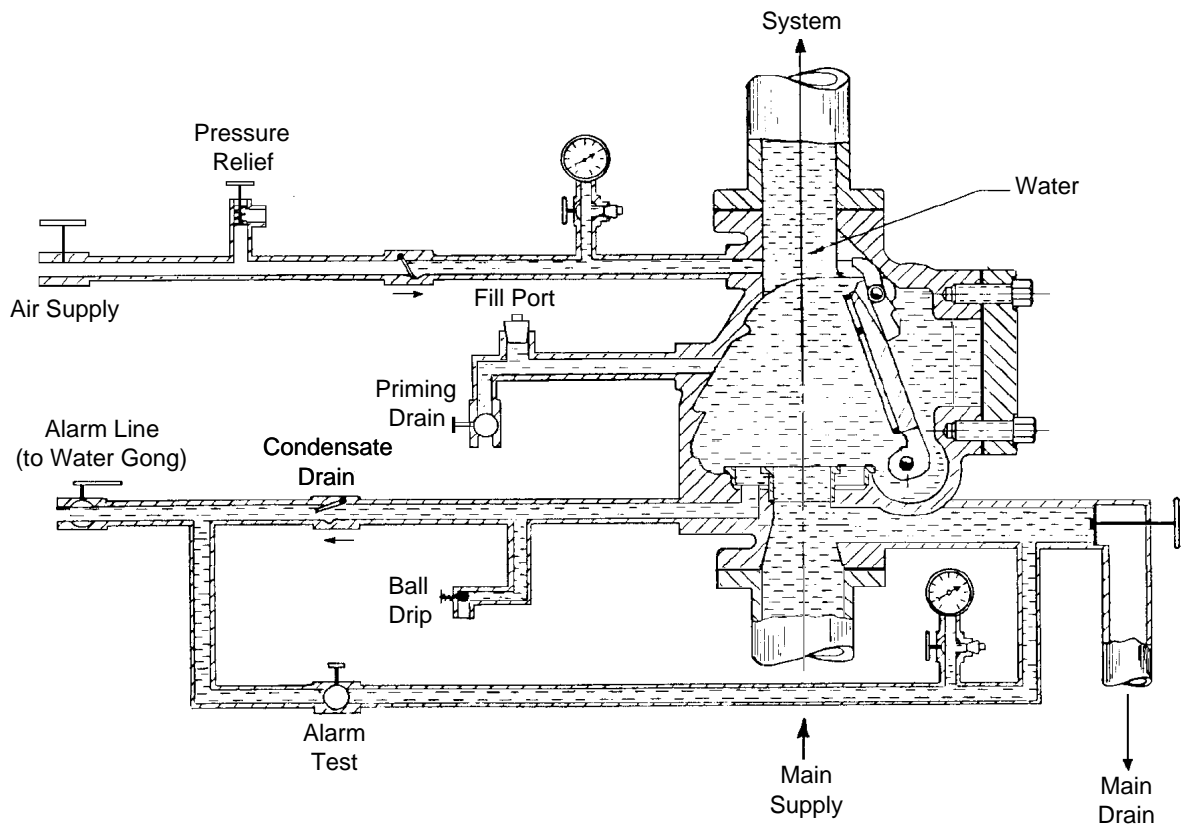
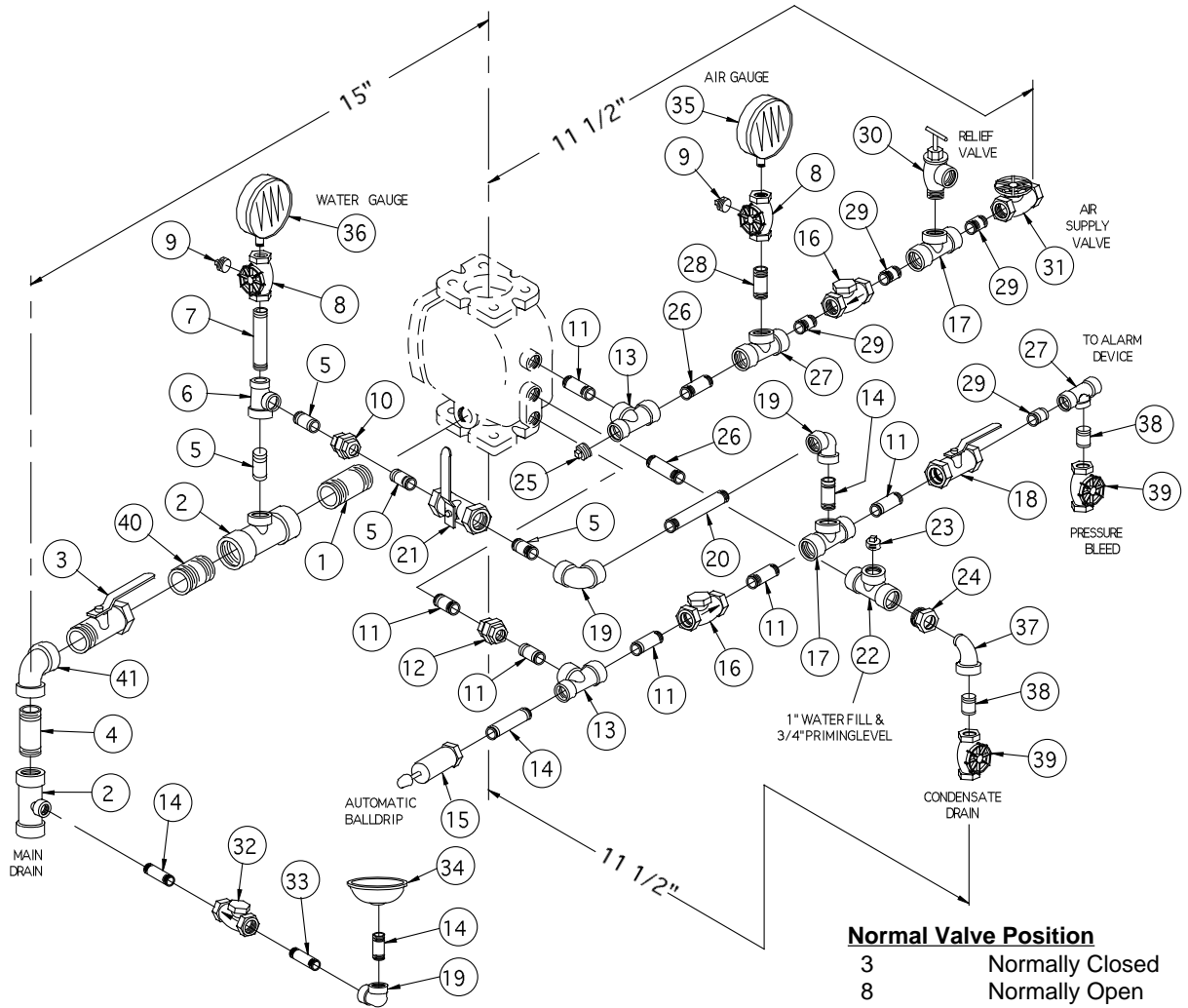

Figure 5
Trim Assembly Diagram - 2" & 2 1/2" Dry Pipe Valve
Model AF



- Normal Valve Position**
- 3 Normally Closed
 - 8 Normally Open
 - 18 Sealed Open
 - 21 Normally Closed
 - 23 (Plug) Normally Screwed Tight
 - 31 Normally Open
 - 39 Normally Closed

* Note: Detail trim kit is available without gauges.

Detail Number	Description	Quantity	Detail Number	Description	Quantity
1	1 1/4" x 2 1/2" Nipple	1	22	3/4" x 3/4" x 1" Tee	1
2	1 1/4" x 1 1/4" x 1/2" Tee	2	23	1" Pipe Plug	1
3	1 1/4" MxF Ball Valve	1	24	3/4" x 1/4" Red. Bush.	1
4	1 1/4" x 4" Nipple	1	25	1/2" Pipe Plug	1
5	1/2" x 2" Nipple	4	26	3/4" x 3" Nipple	2
6	1/2" x 1/4" x 1/2" Tee	1	27	3/4" x 3/4" x 1/4" Tee	2
7	1/4" x 6" Nipple	1	28	1/4" x 2" Nipple	1
8	1/4" 3-way Globe Valve	2	29	3/4" x Close Nipple	4
9	1/4" Pipe Plug	2	30	1/2" Relief Valve	1
10	1/2" Union	1	31	3/4" Globe Valve	1
11	3/4" x 2" Nipple	6	32	1/2" Check Valve	1
12	3/4" Union	1	33	1/2" x 5" Nipple	1
13	3/4" x 1/2" x 3/4" Tee	2	34	1/2" Drip Cup	1
14	1/2" x 1 1/2" Nipple	4	35 *	1/4" Gauge, Air	1
15	1/2" Ball Drip Valve	1	36 *	1/4" Gauge, Water	1
16	3/4" Check Valve	2	37	1/4" 90° Street Elbow	1
17	3/4" x 3/4" x 1/2" Tee	2	38	1/4" x Close Nipple	2
18	3/4" Ball Valve	1	39	1/4" Globe Valve	2
19	1/2" 90° Elbow	3	40	1 1/4" x Close Nipple	1
20	1/2" x 11 1/2" Nipple	1	41	1 1/4" 90° Elbow	1
21	1/2" Ball Valve	1			

Step 5. Remove the valve body Cover and Gasket (Fig. 1, #8 & #9).

Caution: Never attempt to remove the valve cover while the valve is under pressure.

Step 6. Lift the clapper assembly (Fig. 1, #7) and carefully inspect the water seat ring (Fig. 1, #2), air seat ring (Fig. 1, #3), rubber seal (Fig. 2, #3), and valve body interior. Clean if necessary. Do not use cleaning compounds which could damage the rubber seal. Be careful not to scratch or dent the seat rings. Damaged seat rings are not field-replaceable.

Step 7. Verify that the clapper assembly moves freely and that the spring-loaded anti-reseat Latch (Fig. 2, #7) moves freely under hand-applied pressure.

Step 8. Raise the rear portion of the anti-reseat Latch so that it clears the two cast-in-body latching positions, and lower the clapper assembly to the closed and fully-seated position. Do not force the clapper in attempting to make the Dry Pipe Valve tight. Do not use grease or other sealing materials on the seat rings or rubber seal.

Step 9. Reinstall the valve body Cover and Gasket, being careful to tighten the bolts evenly in staggered fashion.

Step 10. Open the Priming Supply Plug (Fig. 5, #23), while making sure that the Condensate Drain Valve (Fig. 5, #39) is closed. Prime the Dry Pipe Valve by slowly pouring water into the Priming Supply. Stop pouring when water remains visible in the Priming Supply Line.

**Note: Priming water is as follows:
2" & 2 1/2" = 3/4 Gallon**

Step 11. Open the Condensate Drain Valve to remove excess priming water from the Dry Pipe Valve.

Step 12. Close the Condensate Drain Valve and replace the Priming Supply Valve.

Step 13. Check the Automatic Ball Drip Valve (Fig. 5, #15) for leakage.

- a. If there is little or no leakage, the clapper is properly seated. Continue with the "Setting Procedure".
- b. If there is leakage, the clapper is not properly seated, and the priming water is leaking past the air seat into the intermediate chamber. The Dry Pipe Valve must be re-opened and repaired. Replace the rubber seal on the clapper if it is worn. After performing the necessary repairs, repeat steps 5 through 13 above.

Step 14. Close the system inspector's test valve.

Step 15. Open the Air Supply Control Valve (Fig. 5, #31) and admit air to the system. If the system is equipped with an automatic Air Maintenance Device, refer to the appropriate Central Bulletin for detailed instructions.

Note: It is good practice to build up the air pressure on the system to 10 psi and then individually open the auxiliary drains to force any remaining water from the low points in the system. When dry air starts to discharge, close the valve(s) tightly and replace the plug or cap.

Step 16. Continue to admit air into the system until the Air Pressure Gauge (Fig. 5, #35) registers the air pressure required to hold the Dry Pipe Valve closed against the water supply pressure. The recommended air pressure is a function of the water supply pressure as follows:

Water (psi)	Air (psi)	
	Min.	Max.
50	15	25
75	25	35
100	35	45
125	40	50
150	40	50
175	40	50

Step 17. Again, check the Automatic Ball Drip Valve for leakage. There should be none.

- a. If there is no leakage, the clapper is properly seated. Continue with the "Setting Procedure".
- b. If there is leakage, the clapper is not properly seated and is not holding the priming water. The Dry Pipe Valve must be re-opened, inspected, and repaired or replaced.

Priming water must be retained in the valve before the system can be placed in service. After correcting any problems, repeat steps 3 through 17.

Step 18. Slowly open the main water supply control valve to the sprinkler system. When water starts to discharge from the main drain, slowly close the main drain valve (Fig. 5, #3). Then fully open the main water supply control valve (O,S&Y, PIV or other).

Step 19. Perform a Main Drain Test (see Main Drain Test Procedure).

Step 20. Open the Alarm Test Valve (Fig. 5, #21), and then perform an Alarm Test (see Alarm Test Procedure).

Step 21. Seal, lock, or otherwise secure the Alarm Control Valve (Fig. 5, #18) and the main water supply control valve in the open position. The system is now ready for service.

Step 22. If alarms connect to a central station or fire department, notify the signal receiving station that the system has been placed in service.



Testing

General

Prior to completion of the installation of a Dry Pipe System, the piping must be tested for strength and water leakage (hydrostatic test) and for air leakage (air test). The test results must be recorded on the Contractor's Material and Test Certificate.

Hydrostatic Test

The 2-hour, 200 psi hydrostatic test of the sprinkler system piping must be conducted with the valve clapper latched in the open position. The rubber seal on the face of the clapper may be ruptured if the valve is tested with the clapper in the closed position. The test should be conducted as weather permits to prevent freezing of the piping.

Air Test

The 40 psi air pressure test of the sprinkler system piping must be conducted to verify there are no leaks that would allow a pressure loss of 1.5 psi or more during the 24-hour test period.

Acceptance Testing

After the installation of a Dry Pipe System is complete and prior to final acceptance by the Authority Having Jurisdiction, the installer must conduct a Main Drain Test, Alarm Test, and Trip Test. The test results must be recorded on the Contractor's Material and Test Certificate.

Refer to the Trim Assembly Diagram (Figure 5) which correlates with the I.D. numbers noted in the following procedures:

Main Drain Test Procedure

The purpose of the Main Drain Test is to show whether or not the normal water supply is available to the system. By comparing the static and residual water pressure readings with any previously established readings, a Main Drain Test can indicate the possible presence of partially closed valves or other obstructions in the

supply piping. To avoid property damage during testing, provision must be made for proper disposal of water issuing from the test outlet.

The procedure for conducting a main drain test is as follows:

Step 1. While the Dry Pipe Valve is "set", and the main drain valve is closed, note and record the reading on the Water Pressure Gauge (Fig. 5, #36). This is the static pressure.

Step 2. Open the main drain valve (Fig. 5, #3) slowly until it is wide open. Verify that a full steady flow of water is discharging from the main drain pipe. If a full steady stream is not discharging, check the main drain piping for obstructions.

Step 3. Allow the water to flow until the reading on the Water Pressure Gauge drops and stabilizes. Then record this reading. This is the residual pressure.

Step 4. Close the main drain valve slowly.

Step 5. Compare static and residual pressure readings with any previously established or normal readings. If the readings compare favorably, the water supply may be considered satisfactory. If the readings vary to any great extent, the condition should be investigated to determine the cause. Some possible causes are:

- a. Partially or totally closed water supply control valves.
- b. Clogged or frozen water supply mains.
- c. Serious leakage at water supply valves or mains.
- d. Significant modifications to the water supply system since the prior test. This may be verified with the local water supply utility or fire department.

Alarm Test Procedure

Unlike wet sprinkler systems, it is not practical to periodically test the operation of the alarm connected to a dry pipe system by opening the inspectors test valve normally located at the most remote position of the system piping. The reason being that

the entire dry system piping would fill with water, hence necessitating time-consuming system draining and re-setting.

If alarms connect to a central station or fire department, notify the signal receiving station prior to and at the completion of the Alarm Test.

The procedure for testing the alarm without tripping the system is as follows:

Step 1. Open the Alarm Test Valve (Fig. 5, #21). This will pressurize the alarm line, cause the pressure alarm switch (if any) to activate and the water motor alarm (if any) to sound.

Step 2. Close the Alarm Test Valve (Fig. 5, #21) to silence the sounding device.

Trip Test Procedure

Dry Pipe Valves should be trip tested during warm weather, preferably in the summer to allow all condensation to drain from the system piping before the onset of cold weather.

Before proceeding with any trip test of a Dry Pipe Valve, the water supply line to the system should be thoroughly flushed. The system main drain may be used for this purpose. If there is a hydrant on the supply line, it should be used to flush the piping before the main drain is opened.

Note: Assistance is required to perform some of the operations in this test procedure.

The procedure for conducting a full-flow trip test is as follows:

Step 1. While the dry pipe system is "in service", open the main drain (Fig. 5, #3) valve slowly until it is wide open. Then check to make sure that a full steady flow of water is discharging from the main drain pipe. Allow the water to flow at full pressure long enough to clear the water supply pipe of any accumulation of scale or foreign material.

Step 2. Slowly close the main drain valve. The Dry Pipe Valve is now ready for Trip Testing.

Step 3. Note and record the readings on the Air Pressure Gauge and on the Water Pressure Gauge.

Caution: Before proceeding, be prepared to record the following information; a watch with a sweep second hand will be required.

- a. Air Pressure reading when the Dry Pipe Valve trips.
- b. The time when the inspector's test valve is opened.
- c. The elapsed time, in seconds, when the Dry Pipe Valve trips.
- d. The elapsed time, in seconds, when water begins flowing from the inspector's test connection.

Step 4. While observing the Air Pressure Gauge, have the inspector's test valve opened by an assistant and note the time.

Note: If two-way communication is not available, the time of opening the inspector's test valve may be determined by observing when the needle on the Air Pressure Gauge starts to move downward.

Step 5. When the Dry Pipe Valve trips, quickly note the time and the reading on the Air Pressure Gauge.

Step 6. Allow water to flow into the system. Note the time when water starts to discharge from the inspector's test connection.

Step 7. Keep the Inspector's Test Valve open until clean water is flowing at the connection. Terminate the test by closing the Inspector's Test Valve and then the main water supply control valve (O,S&Y, PIV or other).

Step 8. Compare the data on trip point pressure, trip time, and water delivery time to the inspector's test connection, with previous test records. If the data differs to any great extent from previous records, the cause should be investigated, and the condition corrected.

Step 9. Drain the Dry Pipe System, thoroughly clean the Dry Pipe Valve, replace parts as required, and reset the valve (see Setting Procedure).

Step 10. The Dry Pipe Valve should be provided with an attached tag which shows the date when the valve was tripped and the name of the person and organization performing the test.

The organization performing the test should maintain separate records which show the test results including: initial air and water pressures, trip time, trip air pressure, water delivery time to the inspector's test connection and operating condition of the Dry Pipe Valve and accessory devices.



Care & Maintenance

The Central Model AF Dry Pipe Valves and their accessory devices (air maintenance device, pressure alarm switch, water motor alarm), should be semi-annually examined by experienced and qualified personnel, to ensure proper operation and trouble-free service.

Warning: Any system maintenance or inspection that involves placing a control valve "out-of-service" will eliminate the fire protection normally provided by the system.

Prior to proceeding, be certain to secure permission from all Authorities Having Jurisdiction and notify all personnel who may be affected during system shutdown. A fire watch during maintenance periods is a recommended precaution.

The owner is responsible for the proper operating condition of all fire protection devices and accessories. The NFPA Standard 25 entitled, "*Inspection, Testing and Maintenance of Water-Based Fire Protection Systems*", contains guidelines and minimum maintenance requirements. Furthermore, the Authority Having

Jurisdiction may have additional regulations and requirements for maintenance, testing and inspection that must be obeyed.

Inspections

The areas of the Dry Pipe Valve and Trim that should be included in semi-annual inspections are described below.

Clapper Seal

(Refer to Figure 2) The rubber seal (#3) should be checked for wear or damage. It should be free of dirt or other foreign substances. If found to be worn or damaged, the rubber seal should be replaced. If it is dirty, it should be cleaned. Compounds which could damage the rubber seal must not be used. The rubber seal should be inspected at any time there is excessive water leakage at the Automatic Ball Drip Valve (#15, Fig. #5).

Clapper Seal Replacement

(Refer to Figure 2) The rubber seal may be replaced by removing the Clapper Assembly and removing the five bolts (#5) holding the Retaining Plate (#4) against the rubber seal and to the clapper (#1).

Seat Rings

(Refer to Figure 1) The air (#3) and water (#2) seat rings should be cleaned and checked for damage such as nicks, scores or dents. **Seat rings are not field replaceable.** A Dry Pipe Valve with damaged seat rings must be replaced. The seat rings should be inspected at any time there is excessive water leakage at the Automatic Ball Drip Valve.

Automatic Ball Drip Valve

(Refer to Figure 5) The plunger on the Ball Drip Valve (#15) should be pushed in during inspection to verify that the ball is free and any slight seepage of water from the intermediate chamber of the Dry Pipe Valve has escaped. Excessive seepage indicates the rubber seal on the valve clapper should be replaced.

Gauges

(Refer to Figure 5) The air (#35) and water (#36) pressure gauges should be checked for accuracy. Verify that the required air pressure is being applied to the system. If the gauges are damaged or non-operational, they should be replaced.

Accessory Devices

The Air Maintenance Device, Pressure Alarm Switch and Water Motor Alarm should be inspected and maintained in accordance with the instructions in the appropriate Central Bulletin and NFPA 25.

Air Pressure

Air (or nitrogen) pressure must be maintained on the dry pipe system throughout the year. Dry pipe systems should not be converted to wet systems during the warm weather season because this will cause increased corrosion and accumulation of foreign matter in the piping. Maximum allowable air pressure leakage is 1.5 psi per 24 hours. If this maximum is exceeded, the leaks should be repaired.

Priming Water Level

(Refer to Figure 5) Loss of priming water either through evaporation into the system or by seepage past the air seat ring, could result in operation of the Dry Pipe Valve. Conversely, accumulation of additional water from condensation in the system could raise the priming water level up into the riser and slow the operation of the valve. Such water clogging above the clapper may result in valve malfunctioning and possible freezing of water in the riser. The Condensate Drain Valve (#39) is utilized to check the priming water level (see Setting Procedure, steps 10 through 12).

The priming water level should be checked at least quarterly.

Periodic Testing.

A Main Drain Test and Alarm Test should be performed on a quarterly basis. A Trip Test should be performed on an annual basis.

When the system is placed back in service after any maintenance, notify all Authorities Having Jurisdiction, and the personnel who were affected during system shutdown.

Guarantee: Central Sprinkler Company will repair and/or replace any products found to be defective in material or workmanship within a period of one year from the date of shipment. Please refer to the current price list for further details of the warranty.

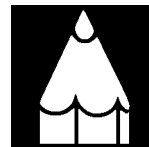

Ordering Information

When placing an order, indicate the full product name. Please specify the quantity, model number, style and size.

The Dry Pipe Valve does not include trim, air maintenance device, pressure switch or water motor alarm. Each must be ordered separately.

The Dry Pipe Valves do not include flange nuts, bolts, and gaskets or mechanical grooved couplings. These items must be ordered separately.

Availability and Service: Central sprinklers, valves, accessories, and other products are available throughout the U.S., Canada, and internationally, through a network of Central Sprinkler sales and distribution centers. You may write directly to Central Sprinkler Company or call (215) 362-0700 for the center nearest you.

Patents: Patents are pending.

Conversion table:

1 inch	= 25.4 mm
1 foot	= 0.3040 M
1 pound	= 0.4536 kg
1 foot pound	= 1.36 Nm
1 p.s.i.	= 6.895 Kpa
	= 0.0689 bar
	= 0.0703 kg/cm ²
1 U.S. gallon	= 3.785 dm ³
	= 3.785 liters

Conversions are approximate.



Central Sprinkler Company

451 N. Cannon Avenue, Lansdale, PA 19446

Phone (215) 362-0700

FAX (215) 362-5385